

GMEPTA9660 (#ARZ86248S) Electric Control Handle with Electric Trigger

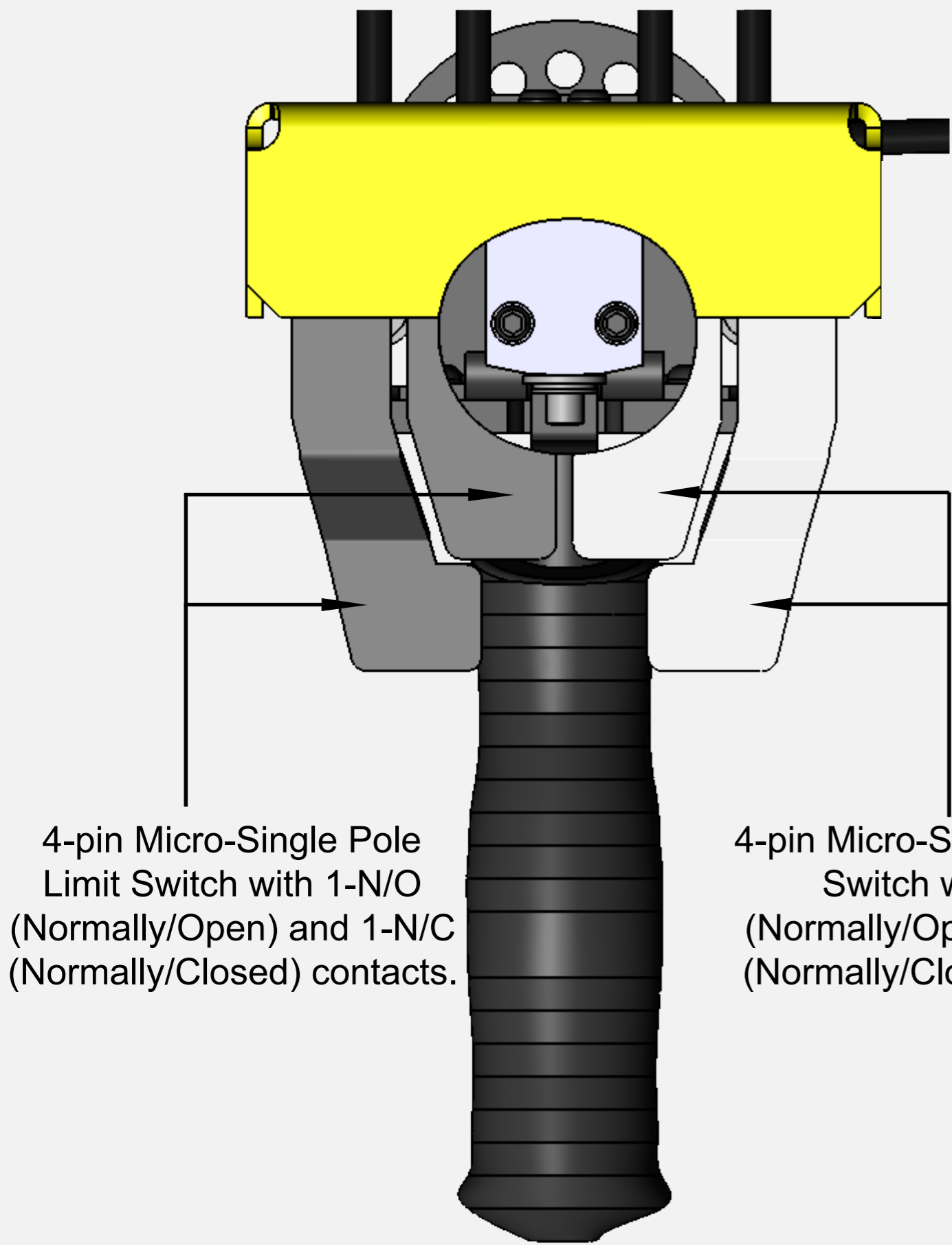

4-pin Micro-Single Pole Limit Switch with 1-N/O (Normally/Open) and 1-N/C (Normally/Closed) contacts.

4-pin Micro-Single Pole Limit Switch with 1-N/O (Normally/Open) and 1-N/C (Normally/Closed) contacts.

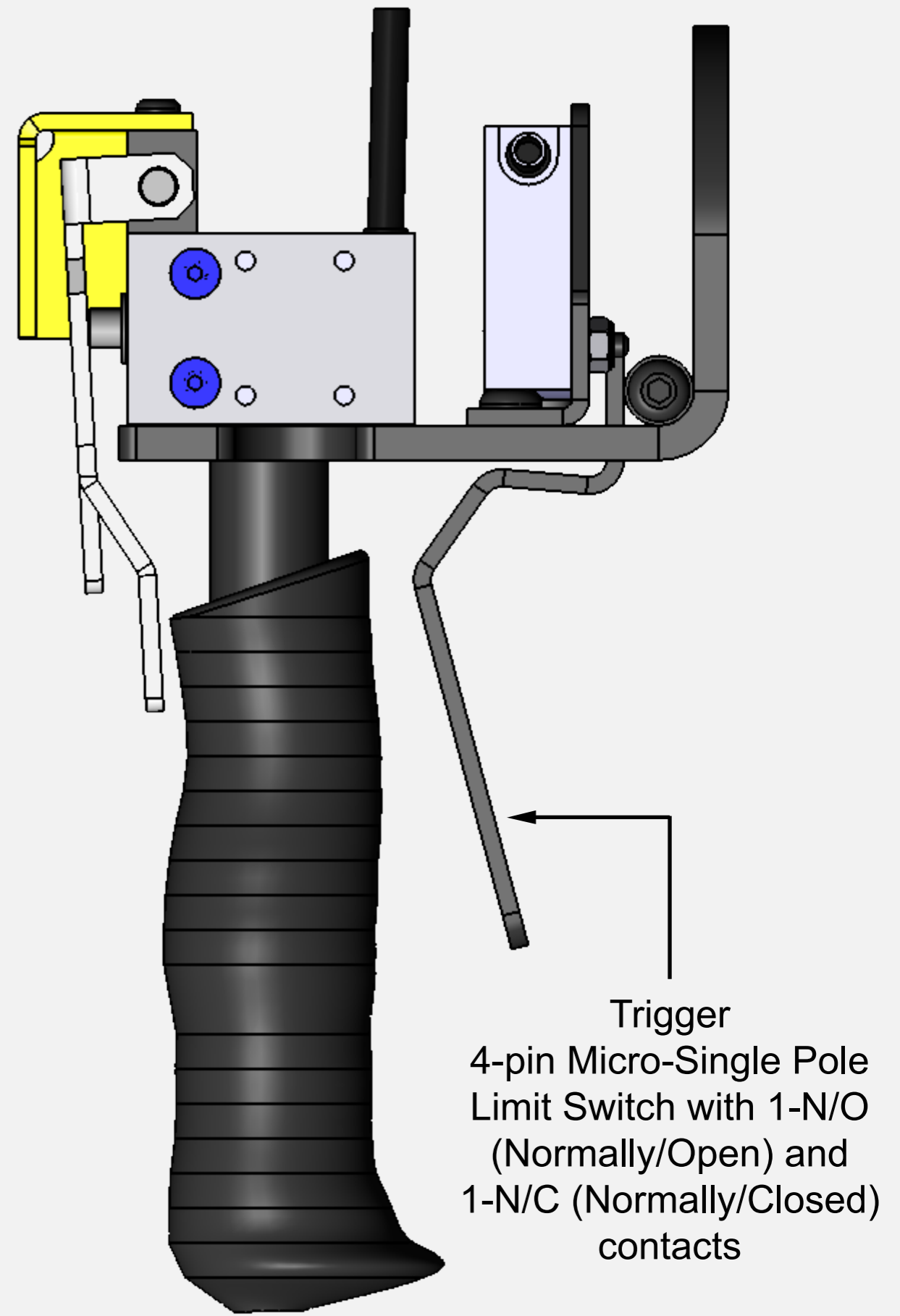

Trigger
4-pin Micro-Single Pole Limit Switch with 1-N/O (Normally/Open) and 1-N/C (Normally/Closed) contacts