

GMEPPTA9660 (#ARZ86326S) Electric Control Handle with Pneumatic Trigger

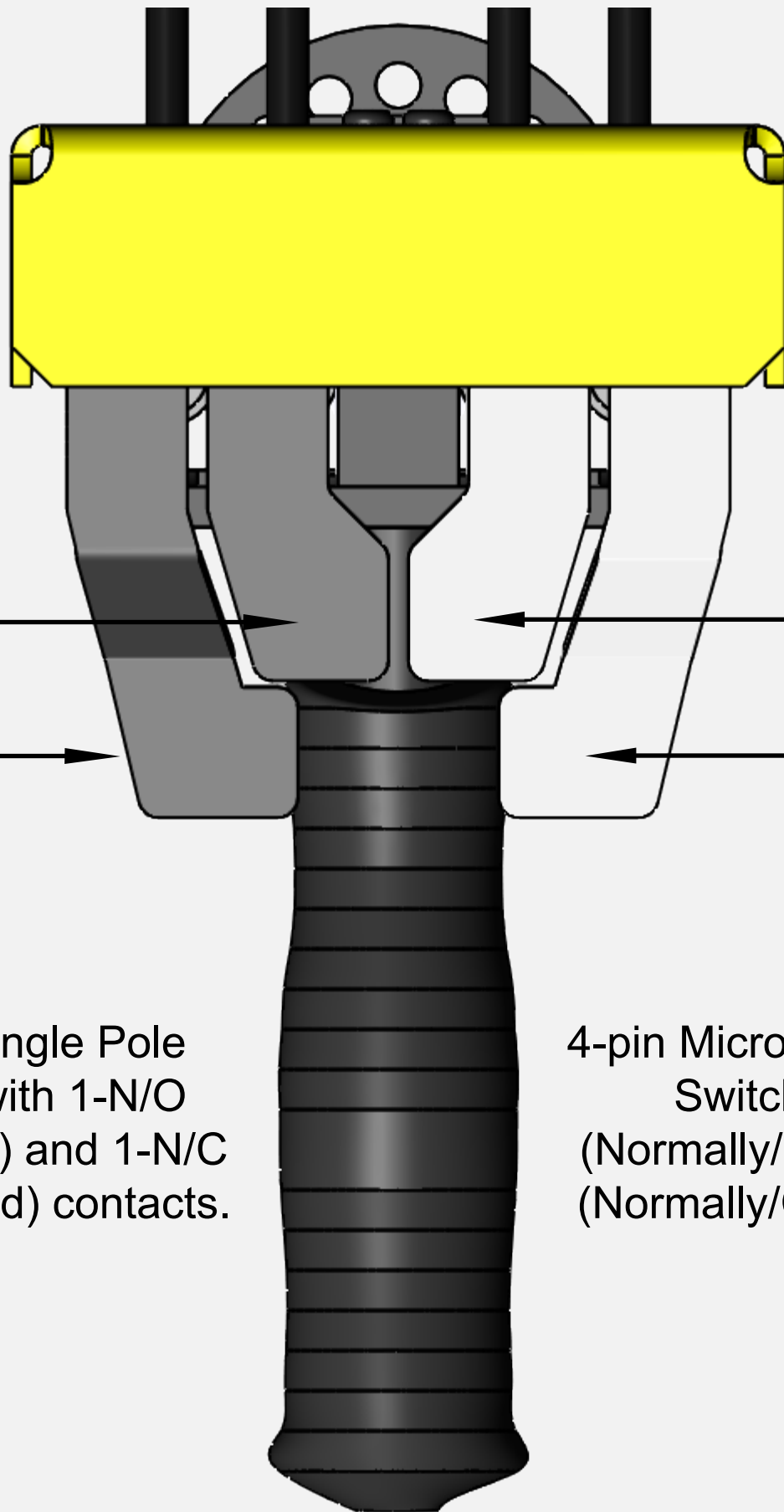

4-pin Micro-Single Pole Limit Switch with 1-N/O (Normally/Open) and 1-N/C (Normally/Closed) contacts.

4-pin Micro-Single Pole Limit Switch with 1-N/O (Normally/Open) and 1-N/C (Normally/Closed) contacts.

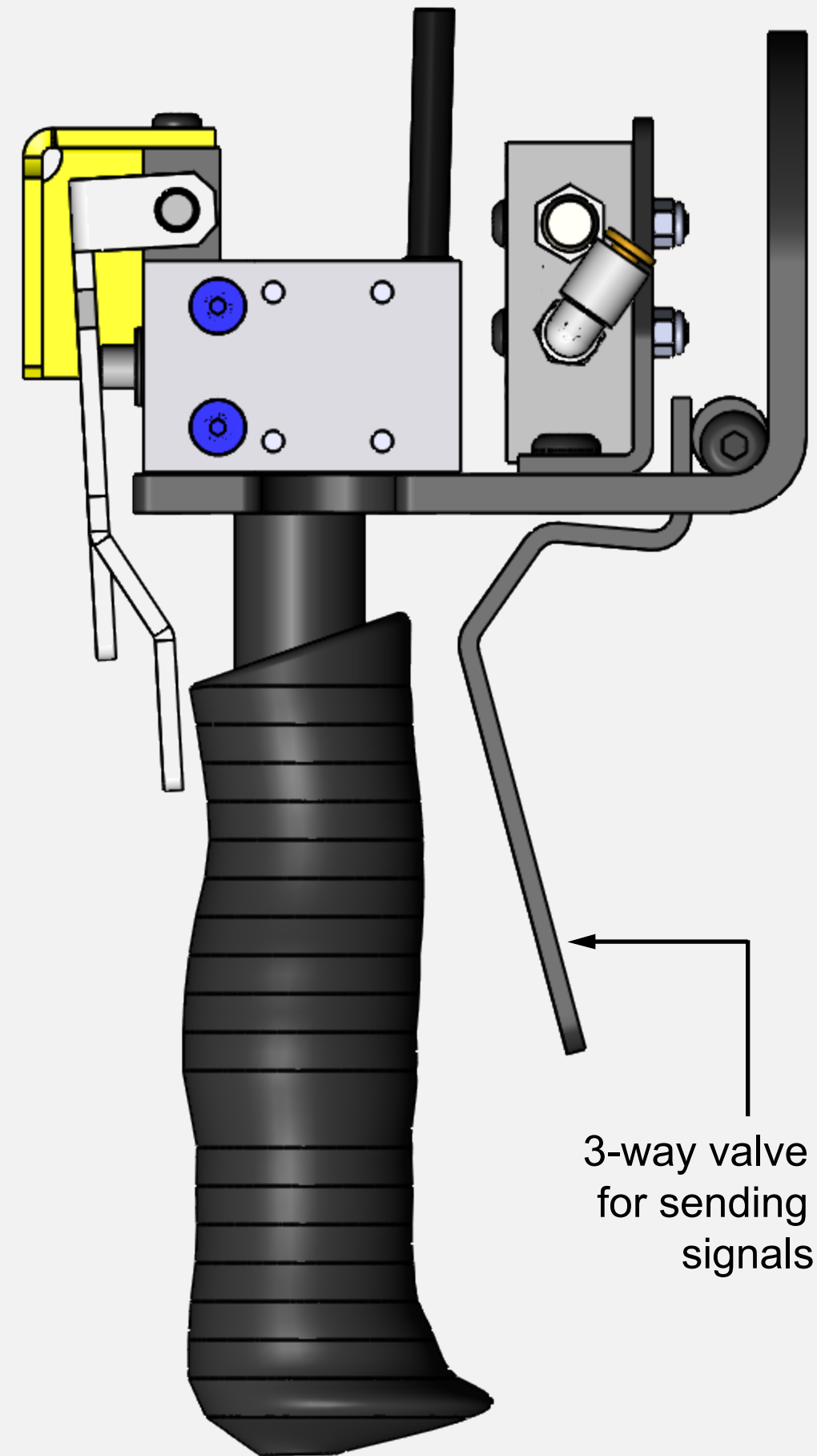

3-way valve used for sending pilot signals