

GMEPPTA9535 (#ARZ86304S) Pneumatic-Electric Control Handle with Pneumatic Trigger

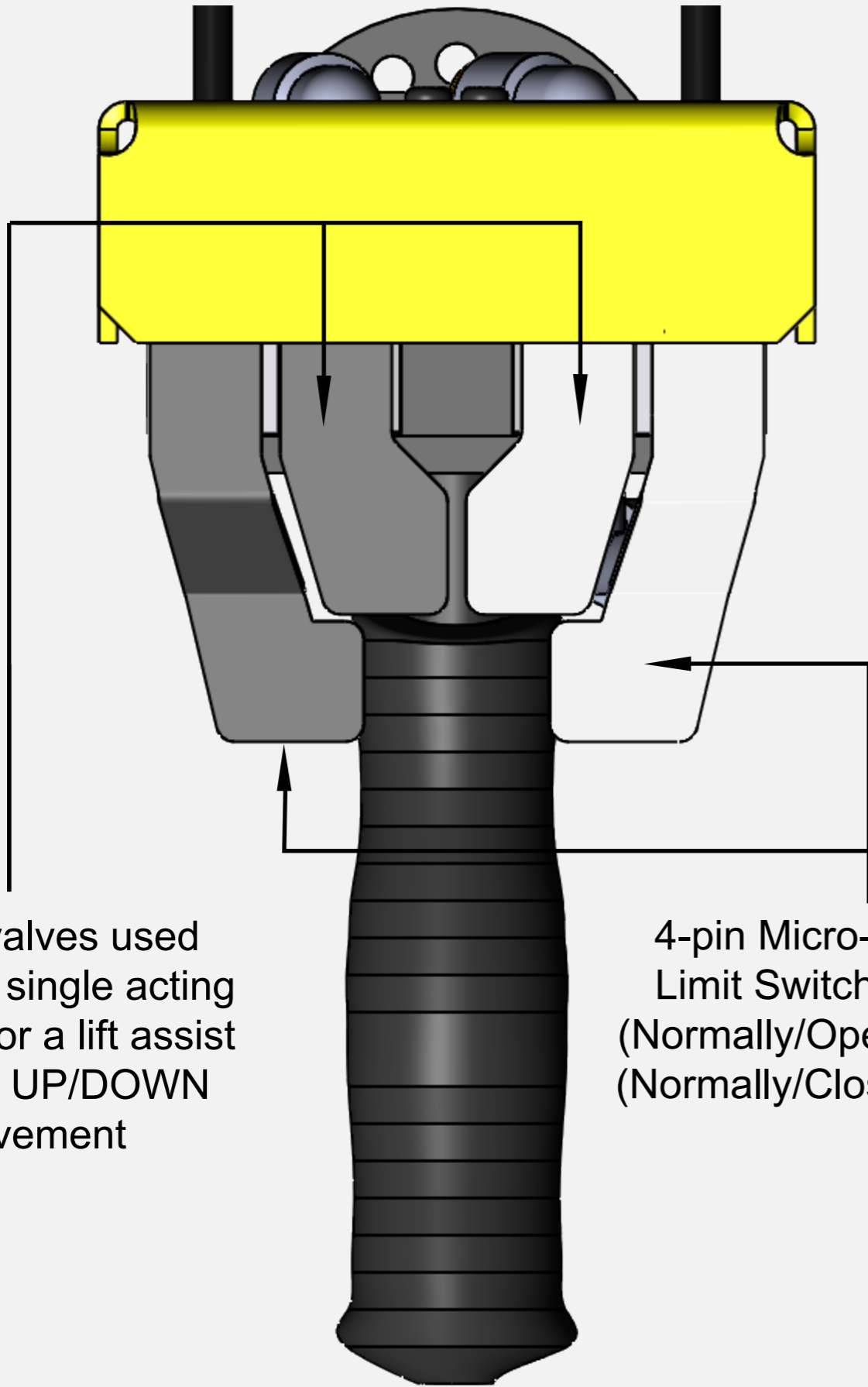

3-way valves used for only a single acting balancer or a lift assist used for UP/DOWN movement

4-pin Micro-Single Pole Limit Switch with 1-N/O (Normally/Open) and 1-N/C (Normally/Closed) contacts.

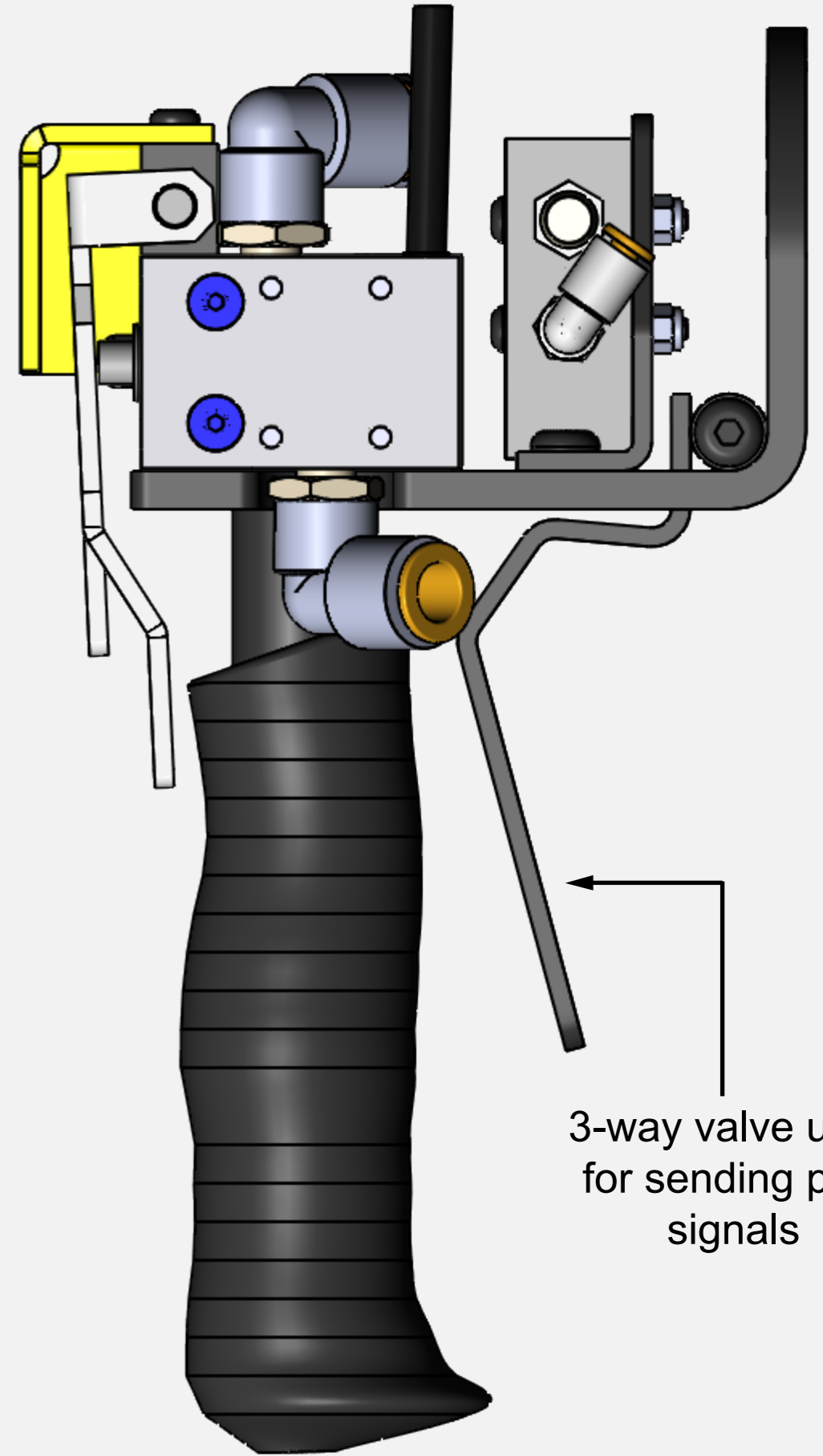

3-way valve used for sending pilot signals