

GMEPPTA9464 (#ARZ86300S) Pneumatic-Electric Control Handle with Pneumatic Trigger

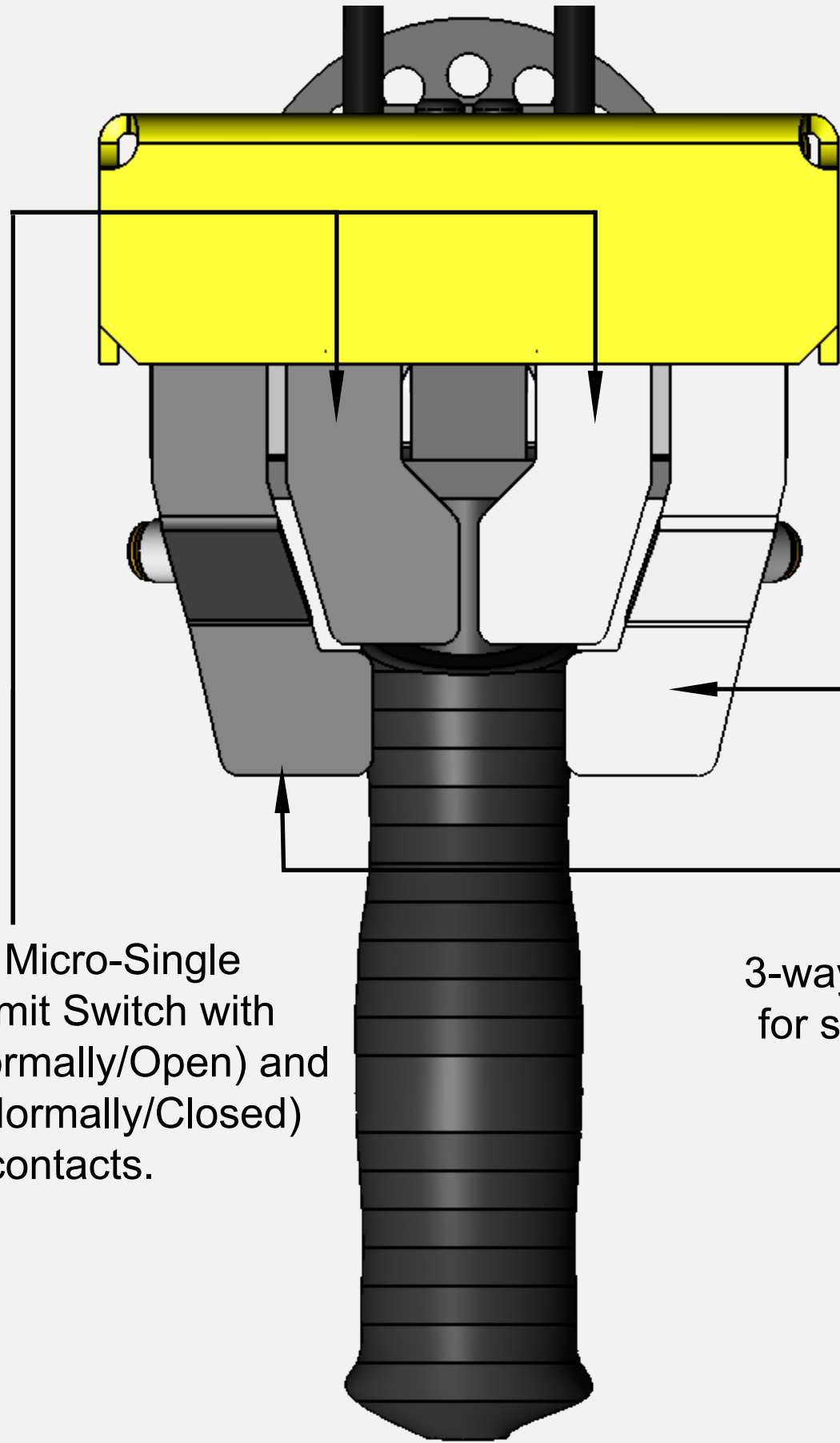

4-pin Micro-Single Pole Limit Switch with 1-N/O (Normally/Open) and 1-N/C (Normally/Closed) contacts.

3-way valve used for sending pilot signals

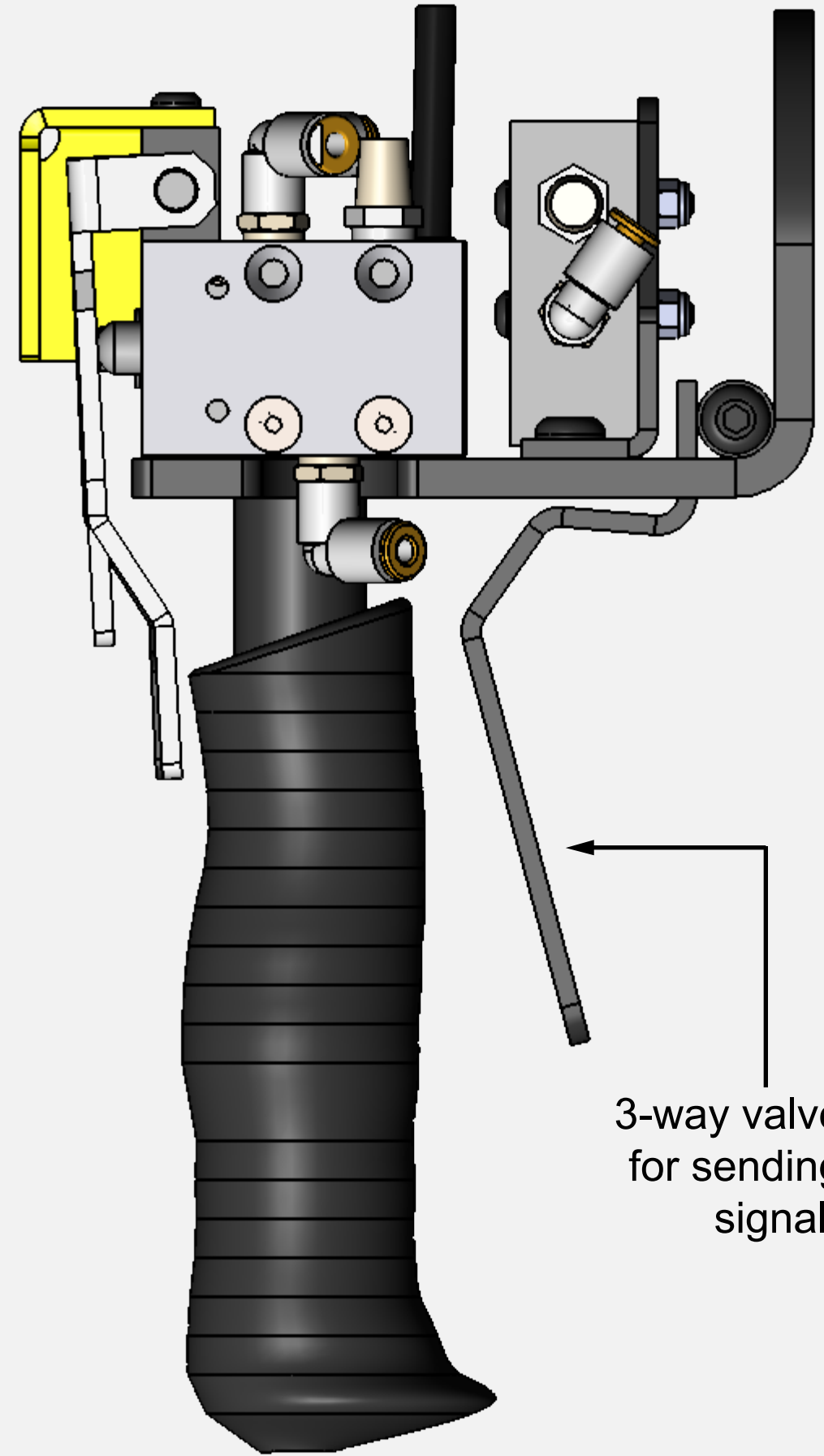

3-way valve used for sending pilot signals