

EPPA9160 Series Pneumatic-Electric Control Handle

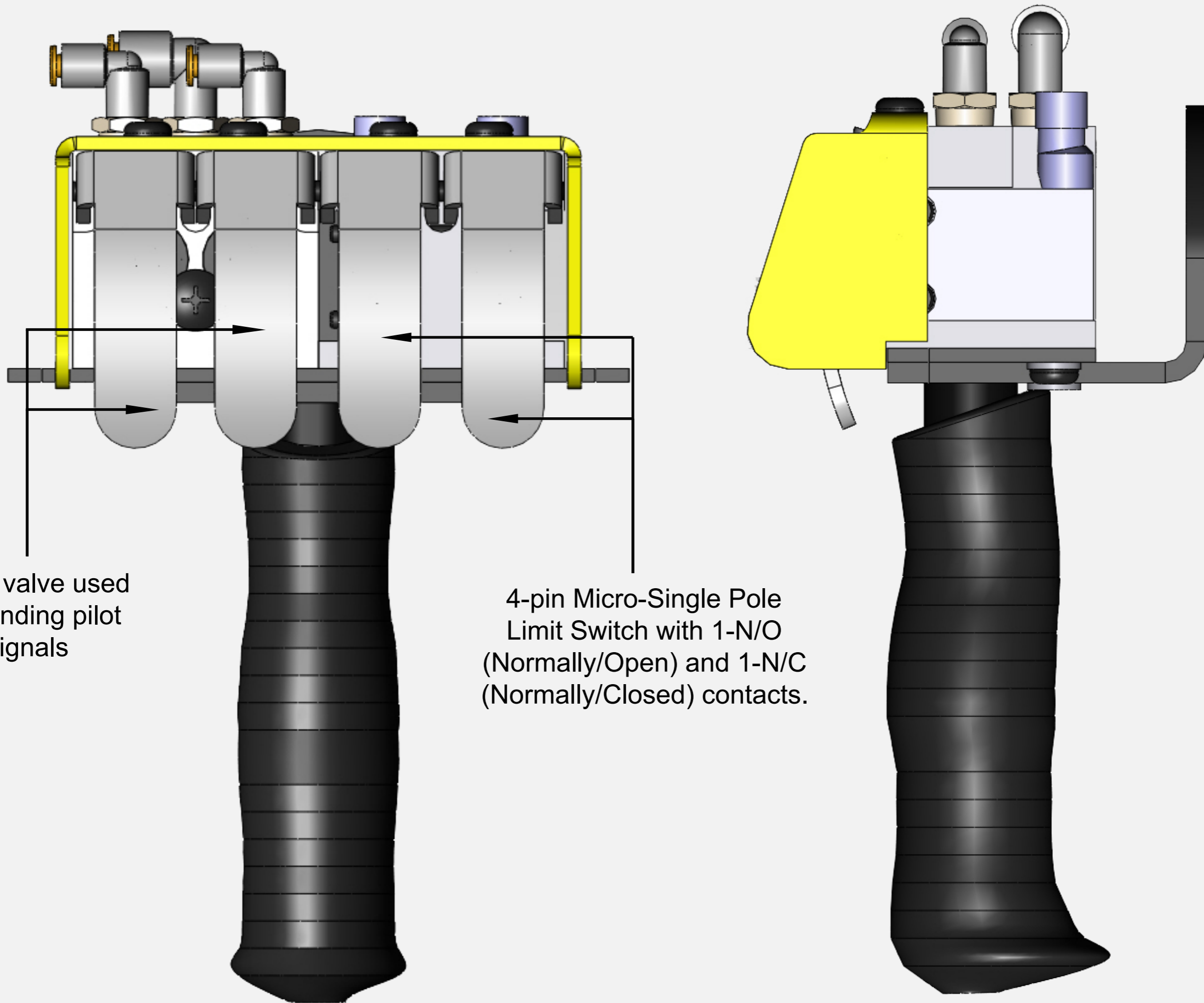

3-way valve used for sending pilot signals

4-pin Micro-Single Pole Limit Switch with 1-N/O (Normally/Open) and 1-N/C (Normally/Closed) contacts.