

BPA9430 Series Pneumatic Control Handle

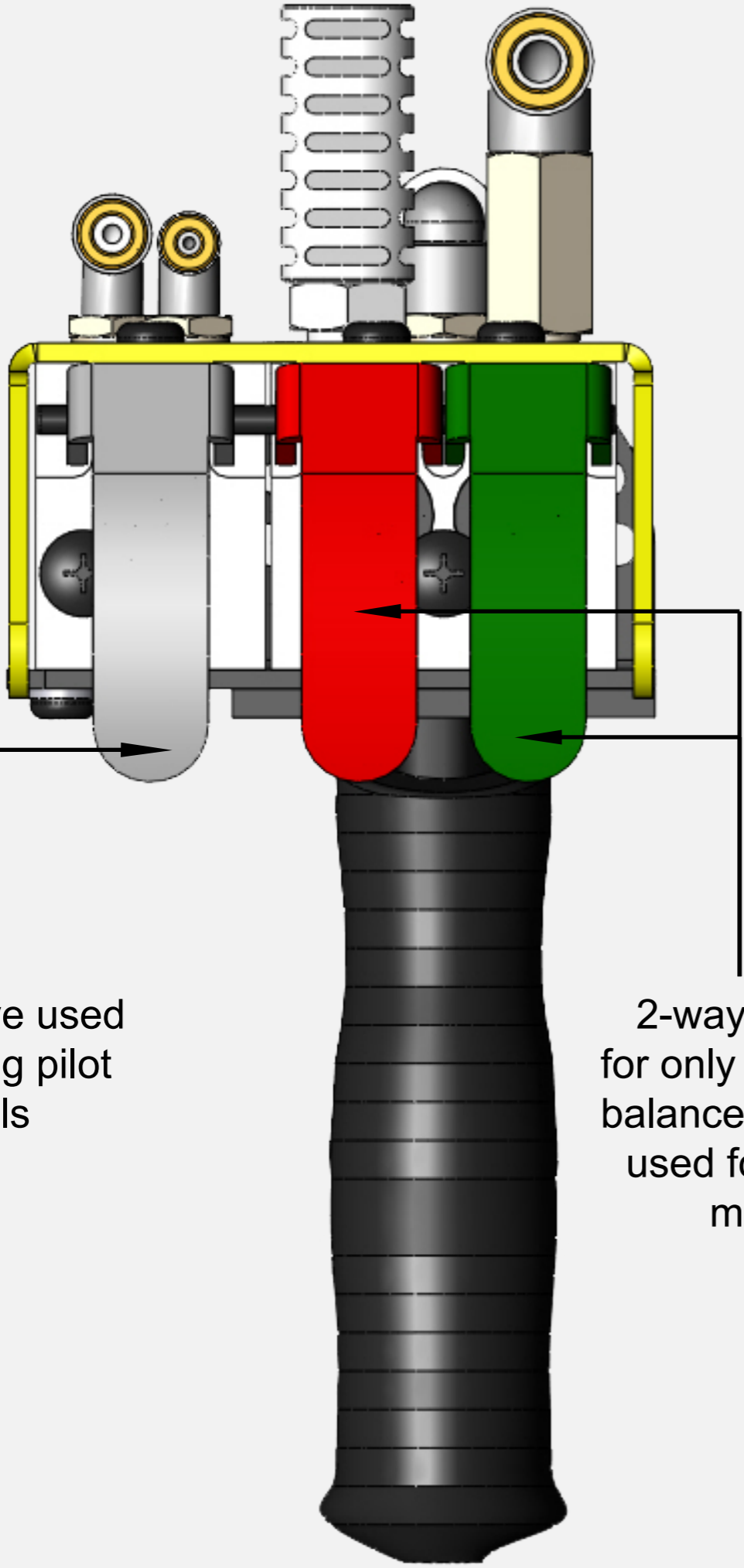

3-way valve used for sending pilot signals

2-way valves used for only a single acting balancer or a lift assist used for UP/DOWN movement

